



**AFRISO sp. z o.o.**

Szałsza, ul. Kościelna 7  
42-677 Czekanów

Tel. + 48 32 330 33 55

Fax + 48 32 330 33 51

zok@afrioso.pl

www.afrioso.pl



## Installation and operation manual

### Polyamide manifolds ProCalida EF1 and EF1 K for underfloor heating and cooling systems



- + Read the manual before using the device!
- + Pay attention to all information regarding safety!
- + Keep the instruction manual!

# Table of contents

1	Explanations to the installation and operation manual.....	3
1.1	Safety messages and hazard categories.....	3
2	Information on safety.....	4
2.1	Intended use of the device.....	4
2.2	Quality control.....	4
2.3	Qualification of personnel.....	4
2.4	Personal protective equipment.....	4
2.5	Modifications of the product.....	4
2.6	Using additional parts and accessories.....	5
2.7	Liability.....	5
3	Product description.....	6
3.1	Construction.....	7
3.2	Dimensions.....	8
3.3	Operation.....	9
3.4	Scope of delivery.....	10
3.5	Technical data.....	11
3.6	Approvals.....	11
3.7	Examples of application schemes.....	12
4	Transport and storage.....	14
5	Installation and commissioning.....	14
5.1	Hydraulic connections.....	14
5.2	Filling and venting.....	17
6	Maintenance.....	17
7	Accessories.....	18
7.1	Configurations of ProCalida EF1 K manifolds with corresponding accessories.....	19
7.2	Configurations of ProCalida EF1 manifolds with corresponding accessories.....	25
7.3	Installation of ProCalida EF1 and EF1 K manifolds with extensions.....	30
8	Spare parts.....	31
9	Decommissioning, disposal.....	32
10	Warranty.....	33
11	Copyright.....	33
12	Customer satisfaction.....	33
13	Addresses.....	33



# 1 Explanations to the installation and operation manual

Installation and operation manual is an important part of the scope of delivery. That is why we recommend:

- ▶ Read the installation and operating instruction before installing the device.
- ▶ Keep the installation and operating instruction for the entire life of the device.
- ▶ Hand over the installation and operating instructions to any subsequent owner or user of the device.

## 1.1 Safety messages and hazard categories

**DANGER** Specifies the type and source of a threat.



- ▶ Describes what to do to avoid a hazard.

Threats have three levels:

Danger	Importance
<b>DANGER</b>	DANGER indicates a hazardous situation, which, if not avoided, will result in death or serious injury.
<b>WARNING</b>	WARNING indicates a potentially hazardous situation, which, if not avoided, can result in serious injury or equipment damage.
<b>NOTICE</b>	NOTICE indicates a hazardous situation, which, if not avoided, can result in equipment damage.



## 2 Information on safety

### 2.1 Intended use of the device

ProCalida polyamide manifolds are designed to distribute the medium in a closed heating or cooling system, using the following media:

- heating water as per VDI 2035,
- a mixture of water and glycol with a maximum concentration of 50%.

ProCalida manifolds are used to connect the heat/cooling source to individual heating/cooling loops. In addition, manifolds allow you to regulate the flow in each loop, as well as vent, drain and fill the system.

Any other use than that indicated in point 2.1 is forbidden.

### 2.2 Quality control

Construction of ProCalida manifolds complies with the current state of the technical standards regarding safety. Each device is checked for safety before shipment.

- ▶ The product should only be used if it is in a qualified technical condition. Read the installation and operation manual as well as observe the relevant safety regulations.

### 2.3 Qualification of personnel

Installation, commissioning, maintenance and decommissioning of this product must be carried out only by a qualified professional with adequate technical training, knowledge and experience to recognize and avoid hazards. To avoid malfunctions and accidents, make sure that all persons using the device are familiar with its operation and Chapter 2 of this manual.

On the basis of their technical training, knowledge and experience, qualified personnel must be able to understand the contents of this manual and all documents relating to the product and recognize possible dangers that may arise from the use of the product.

Qualified personnel must be aware of all applicable regulations, standards and safety rules that must be observed during operation.

### 2.4 Personal protective equipment

Always wear the required personal protective equipment. When working with the product, it must also be considered that hazards may occur at the place of use that are not directly caused by the product.

### 2.5 Modifications of the product

Changes and modifications conducted by unauthorized persons may cause hazards and are prohibited due to safety reasons.



## 2.6 Using additional parts and accessories

Improper additional parts and accessories may damage the device.

- ▶ Use only original spare parts and accessories from the manufacturer.

## 2.7 Liability

The manufacturer is not responsible for direct damages or their consequences resulting from inaccurate reading of installation and operation manual and recommendations.

The manufacturer and the company selling the device are not responsible for damages and costs incurred by the user or third parties using the device, in particular for damage resulting from improper use indicated in chapter 2.1 of installation and operation manual, improper or faulty connection or maintenance and noncompliant operation with manufacturer's recommendations.

AFRISO sp. z o.o. makes every effort to ensure that the information materials do not contain errors. If errors or inaccuracies are found in the following installation and operation instructions, please contact: [zok@afriso.pl](mailto:zok@afriso.pl), tel. +48 32 330 33 55.



### 3 Product description

ProCalida manifolds are designed to connect from 3 to 12 heating/cooling loops to a heat/cooling source. Depending on the version of the manifold, the most important components are:

1. ProCalida EF1 K
  - a. supply beam with rotameters with a flow control range of 0,2 - 1,6 l/min,
  - b. return beam with shut-off valves with nuts,
  - c. wall holders mounted on the beams,
  - d. valves for filling, flushing and draining at the end of each beam.
  
2. ProCalida EF1
  - a. supply beam with rotameters with a flow control range of 0,2 - 1,6 l/min,
  - b. return beam with shut-off valves with nuts,
  - c. wall holders mounted on the beams,
  - d. valves for filling, flushing and draining on each beam,
  - e. 0 - 60°C thermometer on each beam,
  - f. manual air vent on each beam (factory installed),
  - g. automatic air vents with special key for easy installation.

ProCalida EF1 and EF1 K polyamide manifolds have G1" main installation connections. The connections of individual loops have G<sup>3</sup>/<sub>4</sub>" eurocone type threads. The shut-off valves of the individual loops have M30 x 1,5 mm threads. Loop shut-off valves have factory-installed plastic nuts for manual shut-off the flow. ProCalida EF1 and EF1 K manifolds are made of PA 66 polyamide. In ProCalida manifolds, the supply beam is factory located at the bottom, and the return beam from the underfloor installation is located at the top.



### 3.1 Construction



Figure 1: Construction of the ProCalida EF1 K manifold



Figure 2: Construction of the ProCalida EF1 manifold



### 3.2 Dimensions

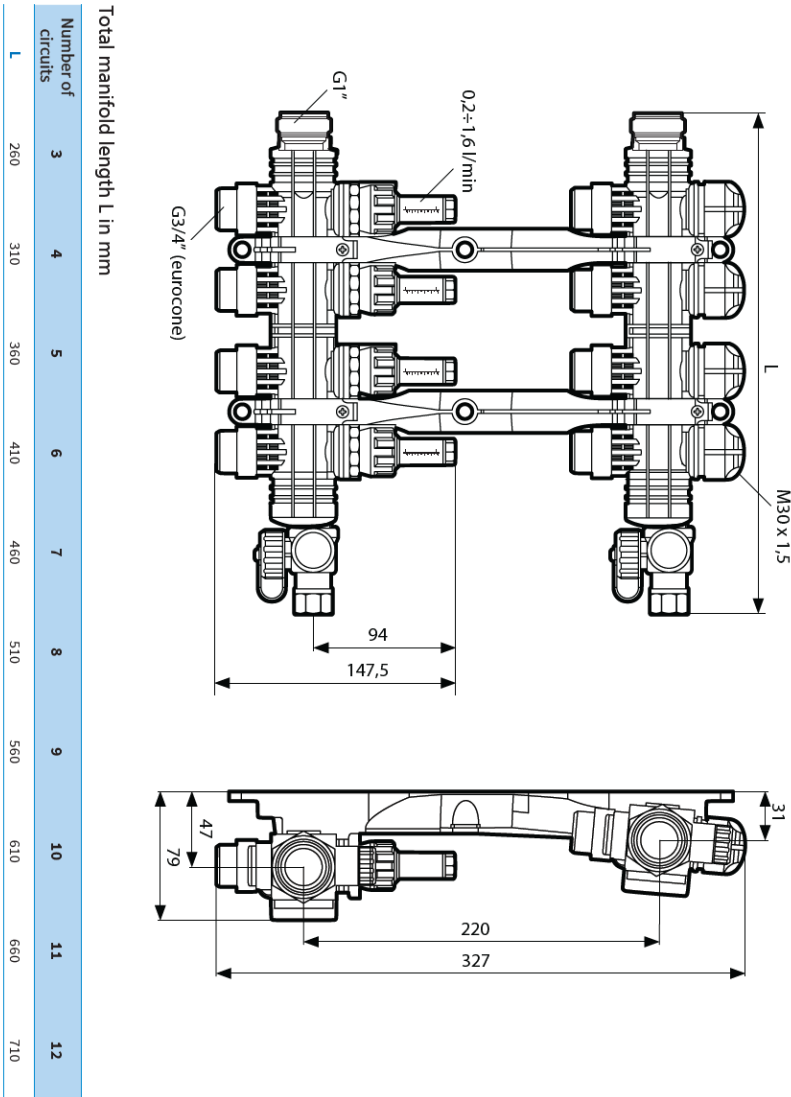

Figure 3: Dimensions of the ProCalida EF1 K manifolds



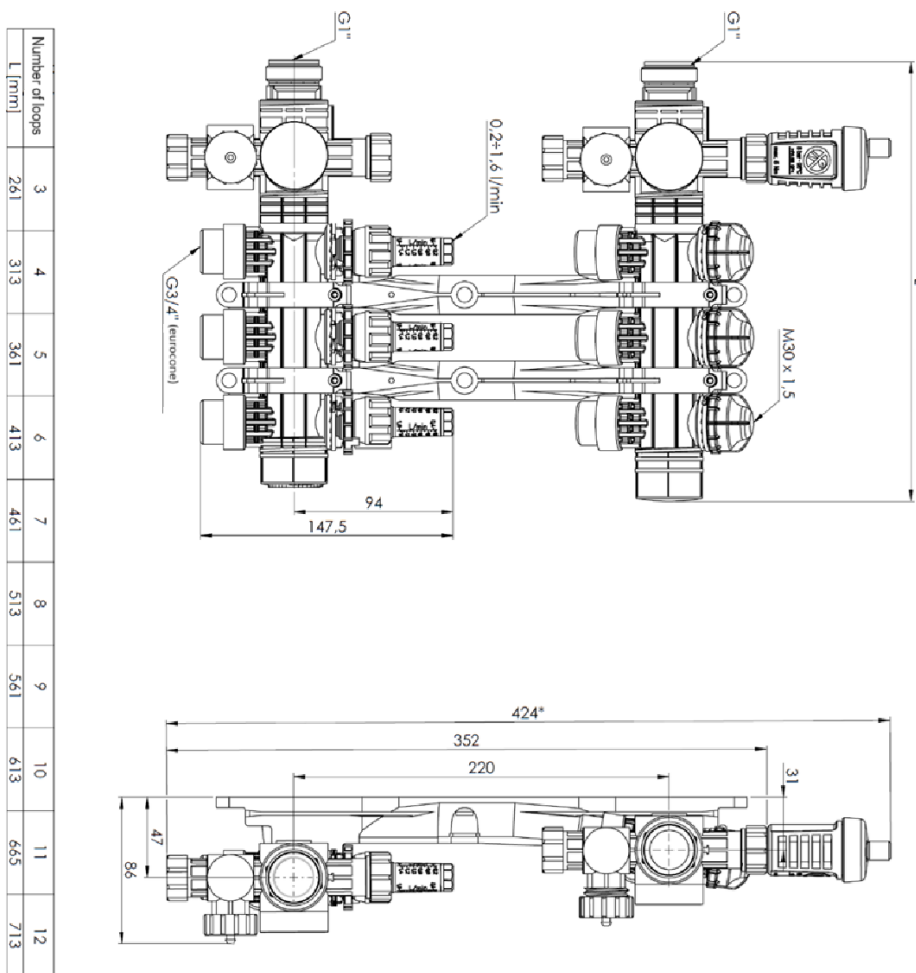

Figure 4: Dimensions of the ProCalida EF1 manifolds

### 3.3 Operation

ProCalida manifolds are used to connect the heating/cooling loops of an underfloor installation with a heat/cool source.

Rotameters located on the supply beam allow precise adjustment of the flow in each loop. The shut-off valve nuts located in the return beam can be replaced with thermoelectric actuators (e.g., TSA AFRISO), which, when connected to a suitable control system (e.g.,



CosiTherm AFRISO), will automatically cut off the flow in the respective loops based on the air temperature in the respective heating/cooling zone.

The valves for filling, draining and flushing installations allow easy filling, venting and cleaning/flushing of a given installation loop. They allow direct connection of a  $\frac{3}{4}$ " flexible hose. The nut on the drain valve prevents accidental draining of the installation of the medium.

A 0÷60°C bimetallic thermometer located on the supply and return beam of the ProCalida EF1 manifold allows you to control the operation of an underfloor installation by reading the temperature on each beam.

A manual air vent located on the supply and return beam of the ProCalida EF1 manifold allows manual venting of the beam. The manual vents can be replaced by polyamide automatic air vents with Aquastop, which are included in the ProCalida EF1 delivery items.

### 3.4 Scope of delivery

The scope of the delivery of the ProCalida EF1 K manifolds include:

- supply and return beam factory mounted on wall holders,
- gaskets for installation connections,
- spare o-rings for connections between sections,
- stickers for marking the loops.

The scope of the delivery of the ProCalida EF1 manifolds include:

- supply and return beam factory mounted on wall holders,
- gaskets for installation connections,
- spare o-rings for connections between sections,
- stickers for marking the loops,
- vent hose,
- a set of polyamide automatic air vents with a special key.



## 3.5 Technical data

Table 1: Technical data of the ProCalida manifolds

Parameter/part	Value/description
<b>General specifications</b>	
Main connections	G1"
Loop connections	G $\frac{3}{4}$ " eurocone
Operating temperature and pressure	max 60°C at 6 bar max 90°C at 3 bar
Manifold flow	max 3,5 m <sup>3</sup> /h
Loop flow coefficient	0,75 m <sup>3</sup> /h
Number of loops	3 - 12 loops
Rotameter range	0,2 - 1,6 l/min
Material	Poliamid PA66 + GF30%

## 3.6 Approvals

ProCalida manifolds for underfloor heating and cooling subject to the Pressure Directive 2014/68/EU and in accordance with art. 4.3 (sound engineering practice) are not CE marked.



### 3.7 Examples of application schemes

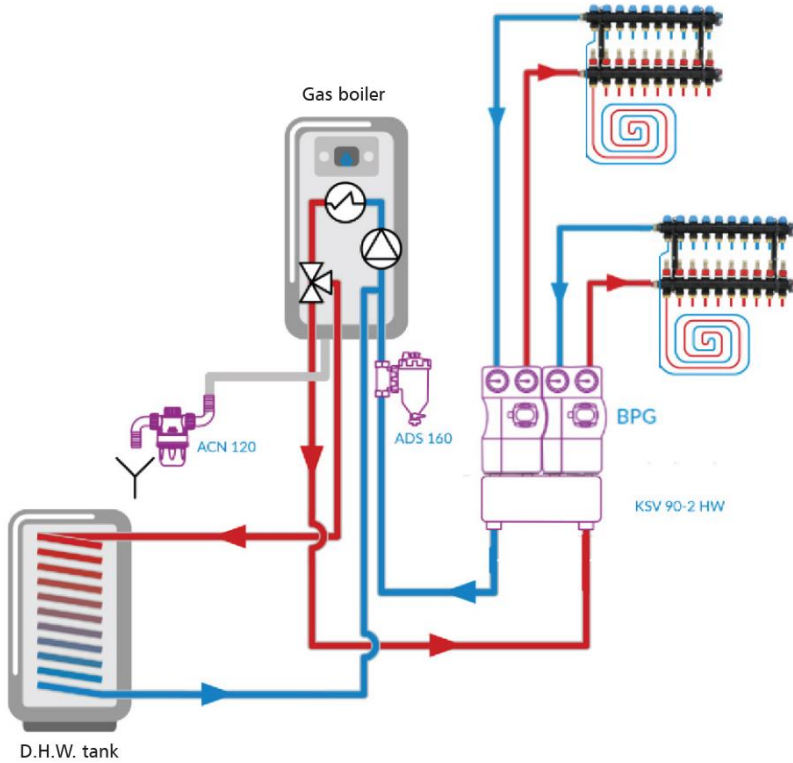

Figure 5: ProCalida EF1 K manifolds used in an underfloor heating installation with gas boiler.

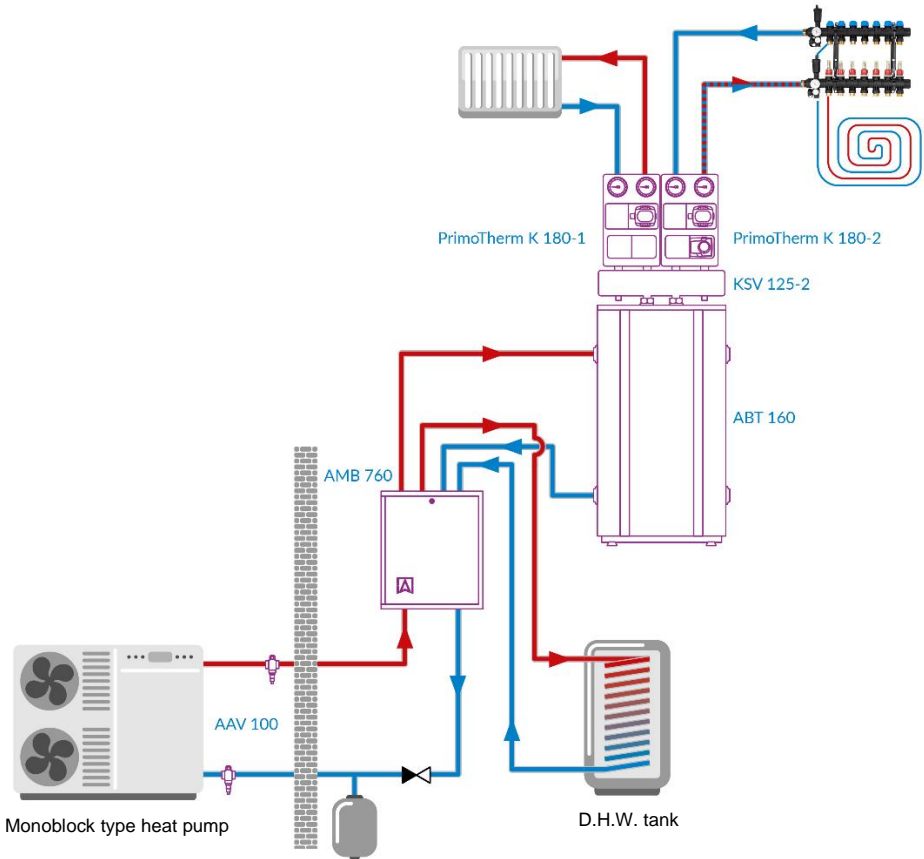

Figure 6: ProCalida EF1 manifold used in a mixed installation with a monoblock type heat pump.



## 4 Transport and storage

**NOTICE** Possibility of damage to the device during improper transport.



- ▶ Do not throw the device.
- ▶ Protect against water, moisture, dirt and dust.

**NOTICE** Possibility of damage during incorrect storage.



- ▶ Store the device in a dry and clean room.
- ▶ Protect against water, moisture, dirt and dust.

## 5 Installation and commissioning

**WARNING** Risk of scalding from hot medium.



- ▶ Hot water burns may occur during installation and maintenance work. Make sure the installation has cooled down before proceeding.
- ▶ Do not touch piping, which can be very hot and cause burns.

The place of installation of the ProCalida manifold must provide protection from the weather. The manifold must not be installed outdoors. The manifold can be installed in any room protected from temperature drop below 5°C. It is designed to be hung on the wall or placed in the frame of a surface or flush-mounted cabinet.

In the case of mounting directly on the wall, appropriate mounting plugs must be selected for the type of wall (not included in the delivery items).

**NOTICE** Possible damage to existing installations.



- ▶ When drilling into walls, take special care not to damage electrical cables or other existing wires.

### 5.1 Hydraulic connections

Before connecting the ProCalida manifold to the heating/cooling installation, the installation should be thoroughly flushed, paying special attention to the removal of residues from soldering, pipe cutting, threading, etc. For additional protection against corrosion and contamination, it is recommended to use in installation corrosion inhibitor BCI AFRISO and magnetic dirt separator ADS AFRISO. To facilitate installation, filling/venting and subsequent maintenance work between the manifold and the source, it is recommended to install shut-off valves. Dedicated polyamide shut-off valves with thermometers (Art.-No. 81 275) can be used.

ProCalida EF1 and EF1 K manifolds are factory mounted on wall holders. The beam with rotameters supplying the underfloor installation is in the lower brackets, while the return beam with shut-off valves is in the upper brackets. This mounting method saves space and protects the thermoelectric actuators (not included in scope of delivery) from potential flooding.

Connect the main connections of the installation using the flat gaskets included in the package. Connect the supply from the source to the bottom beam with rotameters, while the return to the source to the top beam with loops shut-off valves. If you want to connect the ProCalida EF1 K or EF1 manifold from below, use polyamide elbows with extension (Art.-No. 81 274). The procedure for assembling manifold with this accessory is shown in section 7.1 and 7.2.

To connect heating / cooling loops, use couplings that match the diameter of the pipe used.

Before installing the loops, make sure that the upper beam is in a slightly slanted position and the lower beam is in a straight position. To change their position, loosen the screws on the clamps and adjust the slope of the beams accordingly. This will make it easier to guide the loop pipes to the connections in the manifold.

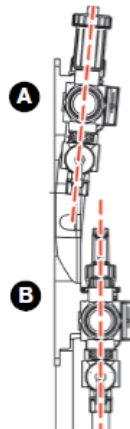

*Figure 7: Correct slope of the beams, making it easier to connect the loop of the under-floor installation*

When installing a ProCalida EF1 or EF1 K manifold with an AFRISO BTU / BRU module, it is necessary to swap the supply beam with the return beam, so that the supply beam with rotameters is in the upper bracket. To do this, unscrew the screws securing the bracket clamps, then swap the beams in place and then re-screw the brackets.

The delivery components of the ProCalida EF1 manifold include polyamide automatic air vents, with which you can replace the manual air vents pre-installed in the beams. The automatic air vents should be screwed into the manifold after the installation has been initially filled and vented. In the first step, the manual air vents should be unscrewed to the maximum and then the manual air vents should be removed with the special installation key provided with the automatic vents.

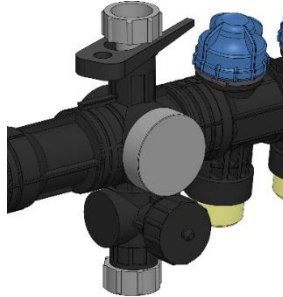

*Figure 8: Removing the manual air vent with a wrench*

Automatic air vents should be screwed into the empty connection.

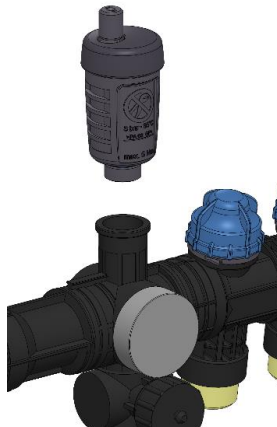

*Figure 9: Screwing the air vent into the empty connection*

Be sure to keep the air vent cap as tight as possible - air vents are equipped with the Aquastop system. These are special seals located in the air vent cap to protect against flooding if the internal float is blocked.





## 5.2 Filling and venting

In order to carry out the optimal process of filling and venting all loops of the underfloor installation, it is recommended to fill the loops through the manifold while shutting off the rest of the installation.

To do this, it is necessary to:

1. Cut off the manifold from the rest of the installation with shut-off valves.
2. Cut off all supply and return loops by turning off the rotameters and shut-off valves.
3. The medium source should be connected to the fill and flush valve located on the supply beam with rotameters.
4. To the valve located on the return beam should be connected a pipe that discharges the medium, depending on the method of filling to the flushing machine or to the sewage system.
5. Open the valves for filling and flushing the installation by unscrewing the white knob.
6. Open the rotameter and shut-off valve on one loop only. Make sure that the pressure of the medium with which the loop is filled does not exceed 4 bar.
7. Rinse the loop thoroughly to get rid of all the air.
8. Close the shut-off valve on the return beam, allow the medium until the appropriate pressure is reached.
9. Cut off the flow on the rotameter.
10. Repeat steps 5-9 for subsequent loops.
11. Once all loops on the manifold have been vented and filled, make sure that all loops are cut off at the rotameters and shut-off valves. At this point, the rest of the installation can be filled without the risk of air being forced into the loops.

When filling the entire installation at the source, manual air vents (ProCalida EF1), or fill, vent and flush valves (ProCalida EF1 K) can be used to get rid of air from the beams space. When flushing the entire installation through, for example, an AFC AFRISO valve, one loop should be opened or a bypass should be made with a flexible hose on the valves for flushing, venting and draining the installation in order to preserve the flow.

## 6 Maintenance

ProCalida EF1 and EF1 K polyamide manifolds are fully maintenance-free devices. It is necessary to periodically (at least once a year) check the tightness of the connections between the installation and loops and carry out a visual inspection of the condition of the manifold for mechanical damage, corrosion and leakage.





If automatic air vents are installed on the manifold, it is also necessary to check the correctness of their operation. To do this, unscrew the caps of the air vents. The outflow of water at this point, will signal the blockage of the float and malfunction. To do this, unscrew the air vent from the installation, after turning off the rotameters, shut-off valves at the ends of the loops and shut-off valves before the manifold. After unscrewing the air vent from the manifold, remove the cap with Aquastop seals from the air vent and dry them. Then flush the air vent to unblock internal float and clean it. After cleaning the air vent, install the cap and the air vent itself back onto the manifold. Make sure that the cap is tightened.

## 7 Accessories

Art.-No.	Name	Compati- lity*	Figure
80 839	Bypass with differential pressure relief valve, 0,1÷0,5 bar	ProCalida EF1, EF1 K	
81 274	Set of two elbows with extension part	ProCalida EF1, EF1 K	
81 275	Set of two G1" F shut-off valves with thermometers	ProCalida EF1**, EF1 K	
81 276	Polyamide RF pressure gauge, 0÷10 bar, G3/4" euroconus nut	ProCalida EF1, EF1 K	
942 000 78	Mounting wrench for rotameters and valves	ProCalida EF1, EF1 K	
80 838	G3/4" F connection for flexible hose	ProCalida EF1, EF1 K,	



81 251	Extension for manifold ProCalida - 1 circuit	ProCalida EF1, EF1 K	
81 252	Extension for manifold ProCalida - 2 circuits	ProCalida EF1, EF1 K	
81 253	Extension for manifold ProCalida - 3 circuits	ProCalida EF1, EF1 K	

\*- ProCalida EF1 manifolds are factory-equipped with elbows with extension (81 274).

\*\* - ProCalida EF1 manifolds have factory-installed thermometers on each beam.

## 7.1 Configurations of ProCalida EF1 K manifolds with corresponding accessories

Some accessories can be combined with each other. The subsections below show accessory configurations with ProCalida EF1 K manifolds.

### 7.1.1 Configuration 1

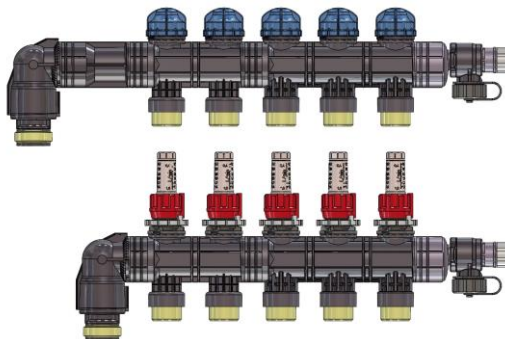

Components used: ProCalida EF1 K + 81 274



### Installation procedure

Step 1. Remove the connections with threads from the beams.

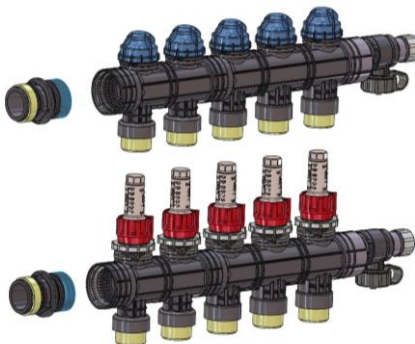

Step 2. Screw the extension and one of the elbows into the upper beam and second to the lower beam.

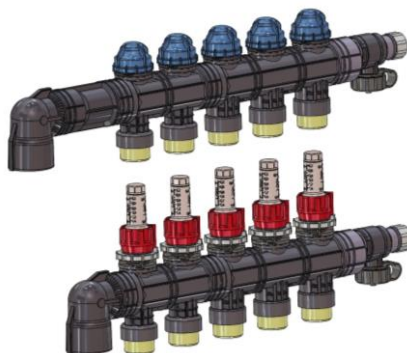

Step 3. Screw the connections with threads into the elbows.

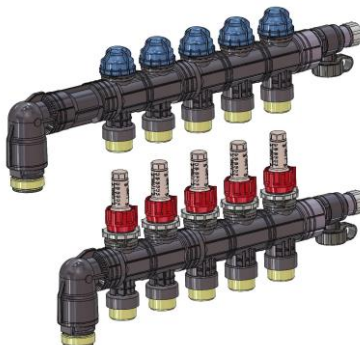



## 7.1.2 Configuration 2

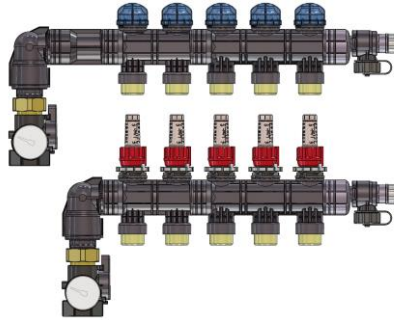

Components used: ProCalida EF1 K + 81 274 + 81 275

### Installation procedure

Step 1. Screw the accessory 81 275 into the assembled manifold according to configuration 1 and place bimetallic thermometers in the slots.



## 7.1.3 Configuration 3

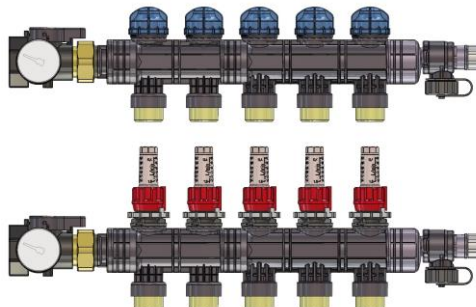

Components used: ProCalida EF1 K + 81 275

Installation procedure

Step 1. Screw the accessory 81 275 directly onto the manifold connections and place bimetallic thermometers in the slots.

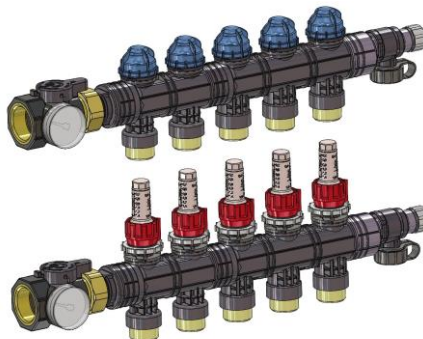

#### 7.1.4 Configuration 4\*

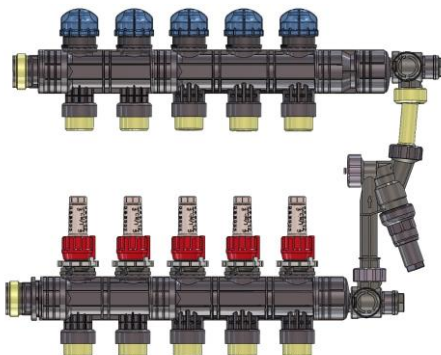

Components used: ProCalida EF1 K + 80 839

Installation procedure

Step 1. Remove the valves at the ends of both beams.

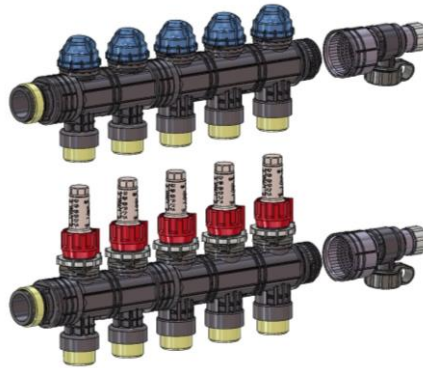

Step 2. Screw the extension and elbow into the upper beam, and the elbow itself into the lower beam.

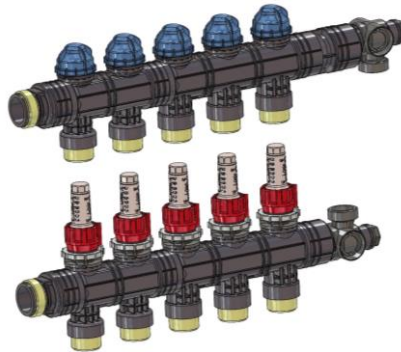

Step 3. Install the bypass in the threads of the elbows.

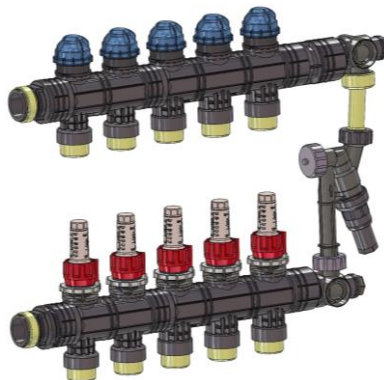



Remaining components after installation.



\*- Before installation, pay attention to the direction of medium flow through the differential pressure bypass valve. The flow can only go from the supply beam to the return beam. This is especially important when swapping beams in place.

### 7.1.5 Configuration 5

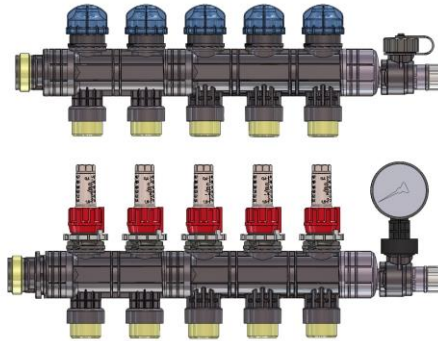

Components used: ProCalida EF1 K + 81 276

Installation procedure

Step 1. Turn the valves upward at the end of the beams.







Step 2. Screw the pressure gauge into the selected beam, after unscrewing the safety plug in the valve. To make the pressure gauge show the pressure, tighten the white shut-off valve in the valve where the pressure gauge was installed.



## 7.2 Configurations of ProCalida EF1 manifolds with corresponding accessories

Some accessories can be combined with each other. The subsections below show accessory configurations with ProCalida EF1 manifolds.

### 7.2.1 Configuration 1\*

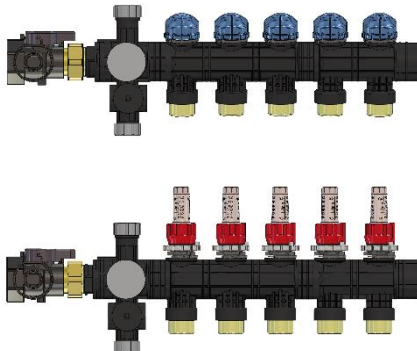

Components used: ProCalida EF1 + 81 275

Installation procedure



Step 1. Screw the accessory 81 275 directly onto the connections of the manifold.

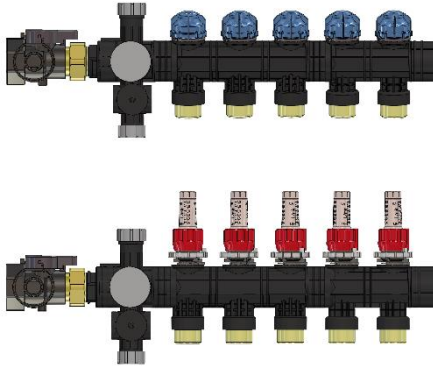

\*- scope of delivery of the accessory 81 275 includes thermometers. As the ProCalida EF1 manifold has thermometers on each beam as standard, it is not necessary to install thermometers on the shut – off valves.

## 7.2.2 Configuration 2

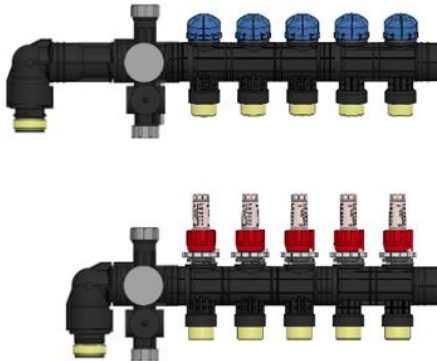

Components used: ProCalida EF1 + 81 274

Installation procedure



Step 1. Remove the connections with threads from beams

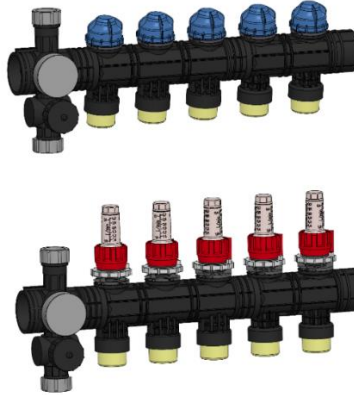

Step 2: Screw the extension and one of the elbows into the upper beam. Screw second elbow to lower beam



Step 3: Screw in main connections with threads



## 7.2.3 Configuration 3\*\*

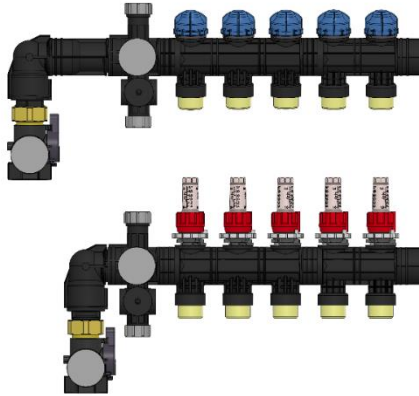

Components used: ProCalida EF1 + 81 274 + 81 275

Installation procedure

Step 1. Screw the accessory 81 275 directly onto the connections of the manifold assembled according to configuration 2.

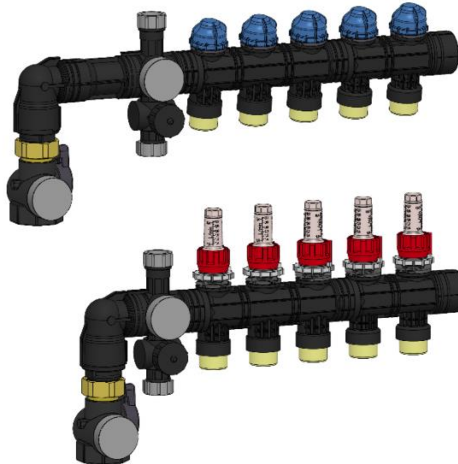

\*\* - the installation of thermometers included in the 81 275 accessory is not required, as the thermometers are pre-installed on the ProCalida EF1 manifold beams.



## 7.2.4 Configuration 4\*\*\*

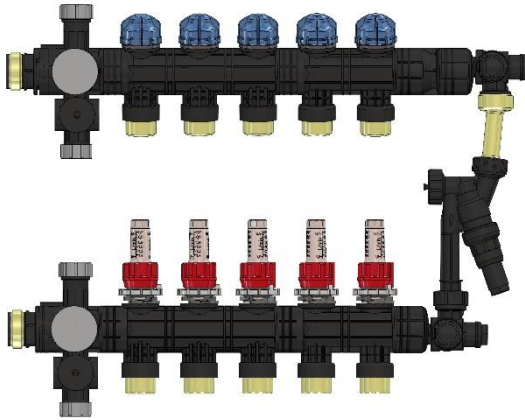

Components used: ProCalida EF1 + 80 839

Installation procedure

Step 1. Remove the plugs on the ends of both beams.



Step 2. Screw the extension and elbow into the upper beam, and the elbow itself into the lower beam. Install the bypass in the threads of the elbows.

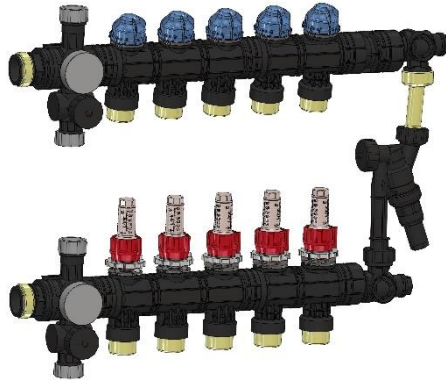

The remaining components after installation are beam plugs.  
 \*\*\*- Before installation, pay attention to the direction of flow of the medium through the differential pressure relief valve. The flow can only be from the supply beam to the return beam. This is especially important when swapping beams in place.

Remaining components after installation.



### 7.3 Installation of ProCalida EF1 and EF1 K manifolds with extensions

The modular design of ProCalida polyamide manifolds makes it possible to install manifold extensions for 1, 2 or 3 circuits. An example of the procedure for assembling a ProCalida EF1 manifold for 5 circuits with a 1-circuit extension is shown below.



Step 1. Remove the plugs at the ends of both beams.

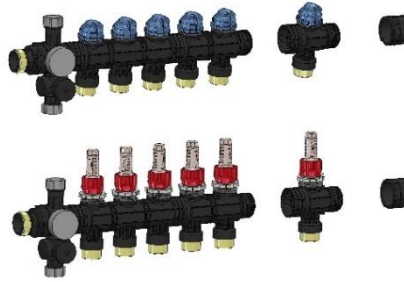

Step 2. Screw in the extensions. Note that a segment with a rotameter should be connected to the supply beam, and a segment with a shut-off valve should be connected to the return beam.



Step 3. Screw in the plugs at the ends of the beams.

## 8 Spare parts

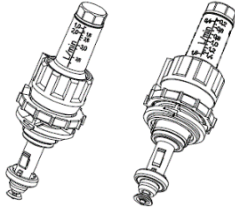
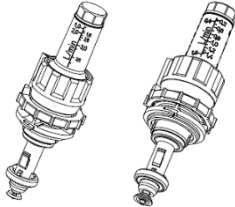
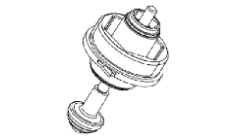
Art.-No.	Name	Compati- bility	Figure
942 000 70	Rotameter with a flow range of 0,2-1,6 l/min	ProCalida EF1, EF1 K	
942 000 71	Rotameter with a flow range of 0,75-3,75 l/min	ProCalida EF1, EF1 K	
942 000 72	Shut-off valve with connection for ther-moelectric actuator	ProCalida EF1, EF1 K	



942 000 73	Blue nut of shut-off valve	ProCalida EF1, EF1 K	
942 000 76	Manifold main connection G1"	ProCalida EF1, EF1 K	
942 000 75	Beam end cap with valve for filling, draining and flushing	ProCalida EF1, EF1 K	
942 000 74	Beam end cap	ProCalida EF1, EF1 K	
942 000 77	Polyamide wall holder for manifold beams	ProCalida EF1, EF1 K	
80 840	Bimetallic thermometers for ProCalida EF1 manifold	ProCalida EF1, accessories	
80 833	Set of two quick air vents	ProCalida EF1	
942 000 79	O-ring sealing the connection between manifold modules	ProCalida EF1, EF1 K	

## 9 Decommissioning, disposal

1. Dismantle the device.
2. To protect the environment, this product must not be disposed of together with the normal household waste. Dispose of the product according to local directives and guidelines.

ProCalida EF1 and EF1 K polyamide manifolds consist of materials that can be recycled.





## 10 Warranty

Product warranty in accordance with the general conditions of sale and delivery.

## 11 Copyright

Copyright to the manual belong to AFRISO sp. z o.o. Reprinting, translation and reproduction, even partial, is prohibited without written permission. Changing technical details, both in writing and in the form of images, is prohibited by law.

We reserve the right to make changes without prior notice.

## 12 Customer satisfaction

For AFRISO sp. z o.o. customer satisfaction is the most important thing. If you have any questions, suggestions or problems with the product, please contact: [zok@afriso.pl](mailto:zok@afriso.pl), phone number +48 32 330 33 55.

## 13 Addresses

The addresses of companies representing the AFRISO group around the world can be found at: [www.afriso.com](http://www.afriso.com).